



Sesame-S

full-height turnstiles

These full-height turnstiles are noted not only for their reliability and affordability, but also for unique design solutions that make them even more convenient and efficient to use.

Sesame-S and Sesame-S Basic



are the perfect solutions for your business or any facility that requires reliable access control

These full-height turnstiles stand out not only for their reliability and affordability, but also for unique design solutions that make them even more convenient and efficient to use.

The SafeLock-EM mechanism, used in these turnstiles, has already gained popularity due to its stability and reliability.



The advantage of Sesame-S and Sesame-S Basic lies in its durability and resistance to vandalism, making it a perfect choice for facilities with high passenger traffic or security requirements.

Sesame-S

full-height turnstiles

Configurations

Classic and Basic

Sesame-S turnstiles offer two options with and without a side fence, each of which has its own advantages.

○ Sesame-S

The version with a side fence impresses with its strength and reliability.

By adding guardrails, we provide additional stability to the structure, making it an ideal choice for high-traffic areas or where safety and reliability are important.



○ Sesame-S Basic

On the other hand, the option without a fence attracts attention with its simplicity and lightness.

The light design makes installation and movement of Sesame turnstiles as convenient and efficient as possible.

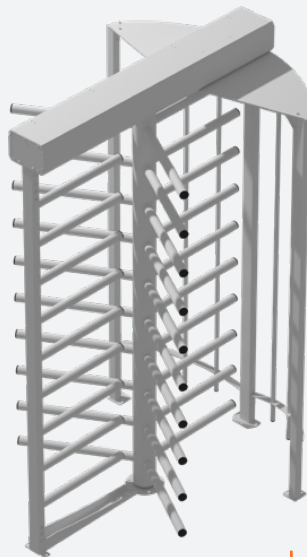

Rotor types

Full-height turnstiles by TISO can have different rotor configurations

○ Y-type

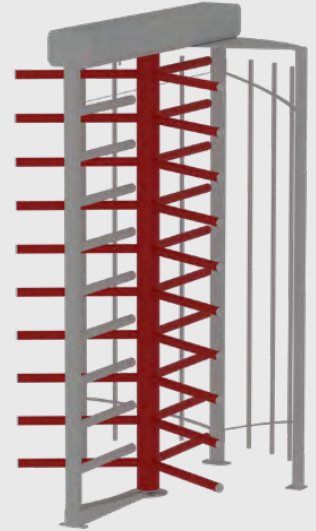

Angle between arms - 120°

○ X-type

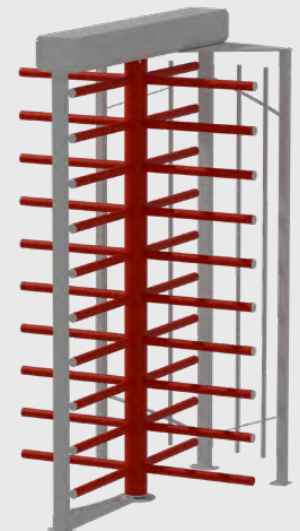

Angle between arms - 90°

Sesame-S

full-height turnstiles

SafeLock-EM mechanism

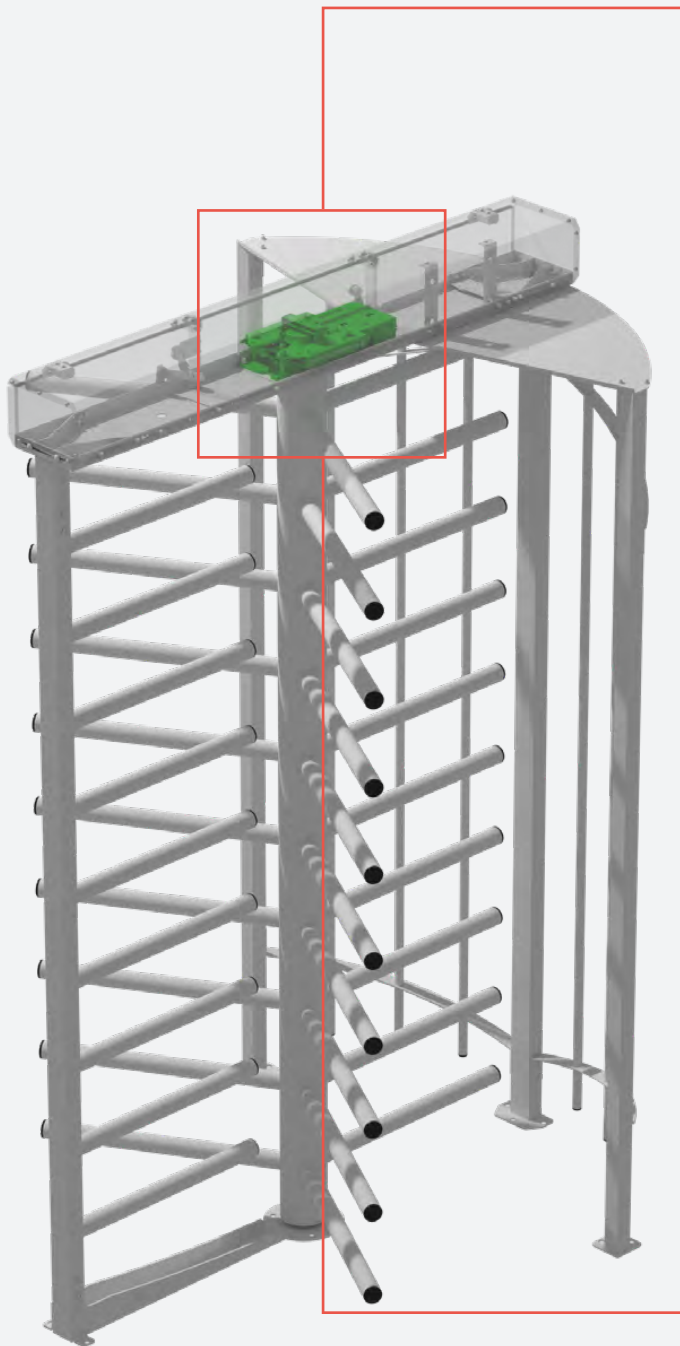

SafeLock-EM is a demandable mechanism with high stability and reliability.

It is ahead of other manufacturers in terms of price.



reduced dimensions of the container, where the mechanism is located



a reliable mechanism, resistant to high loads. Ensures long-term and uninterrupted operation of the turnstile in high-traffic areas



the rotor rotates manually from the positioning by the closer

- MCBF 10,000,000 cycles

Security Level



Price Level



Sesame-S

full-height turnstiles

Key features



Frontal opening of the container

enables installation of the turnstile flush with the ceiling



The unlocking of mechanical locks

automatically activated in fail-secure mode



Integrated LED status display

allows for quickly assessing the status of the turnstile system



Unique fencing design

- ensures maximum durability
- increases the service life of the turnstile
- and reduces potential maintenance costs

Sesame-S

full-height turnstiles

Housing strength

Sesame-S turnstiles series are distinguished by their design, which not only provides convenience in installation and maintenance, but also has high strength and reliability.

○ Canopy

The canopy adds strength and functionality to the turnstile. It strengthens the structure of the turnstile and makes it more reliable. Also, under the canopy, there is LED lighting for the passage, providing additional convenience and safety for users.

○ Inclined membrane

The main feature of these turnstiles is inclined membrane on the housing, which will ensure the stability of this model.

○ Mobile platform

The mobile platform provides ease of installation and efficiency in use. Its main advantage is that it allows you to easily install the turnstile and make all the necessary connections without the need for complex construction work. Ease of disassembly also makes it ideal for situations where it is necessary to quickly move or temporarily install a turnstile. Mobile platform goes optionally.

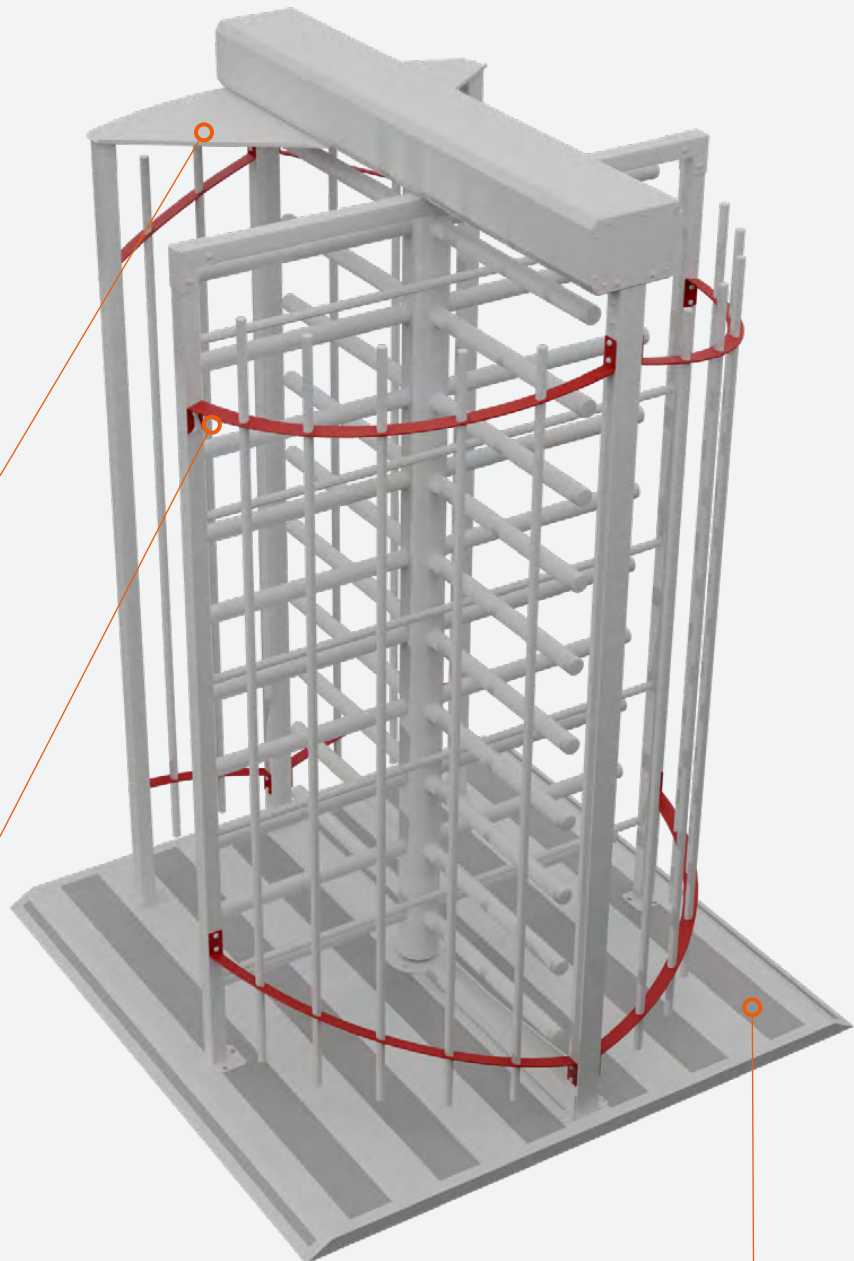

The Sesame-S full-height turnstiles are a reliable and effective access control solution that ensures security and prevents unauthorized access to the facilities. As a result, reliable protection of the territory is guaranteed to you by our full-height turnstiles.



- Highest security level, which can make stricter force control than other type of turnstiles
- Low noise system operation
- Successful combination of affordable price and high quality
- Steadfast housing suitable for high traffic areas
- The ability to customize housing design and top lid
- Low power consumption
- Can be integrated with any type of access control systems
- Wired remote control panel in standard kit
- In case of power failure, rotor locked in both directions (fail secure)

Sesame-S

full-height turnstiles

LED illumination

○ LED lighting of the passage

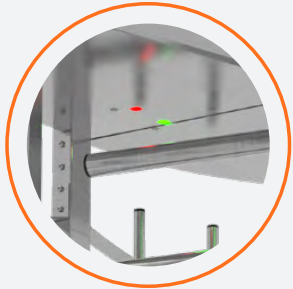

Two LED modules built into the canopy to illuminate the passage area and show the status of the turnstile. Dual mode of passage lighting is an option and can be chosen by the customer: red/green or white.

○ LED status display



GREEN

- passage is allowed

FLASHING GREEN

- free passage permission



RED

- standby mode
- entry is prohibited

FLASHING RED

- blocked passages in both directions

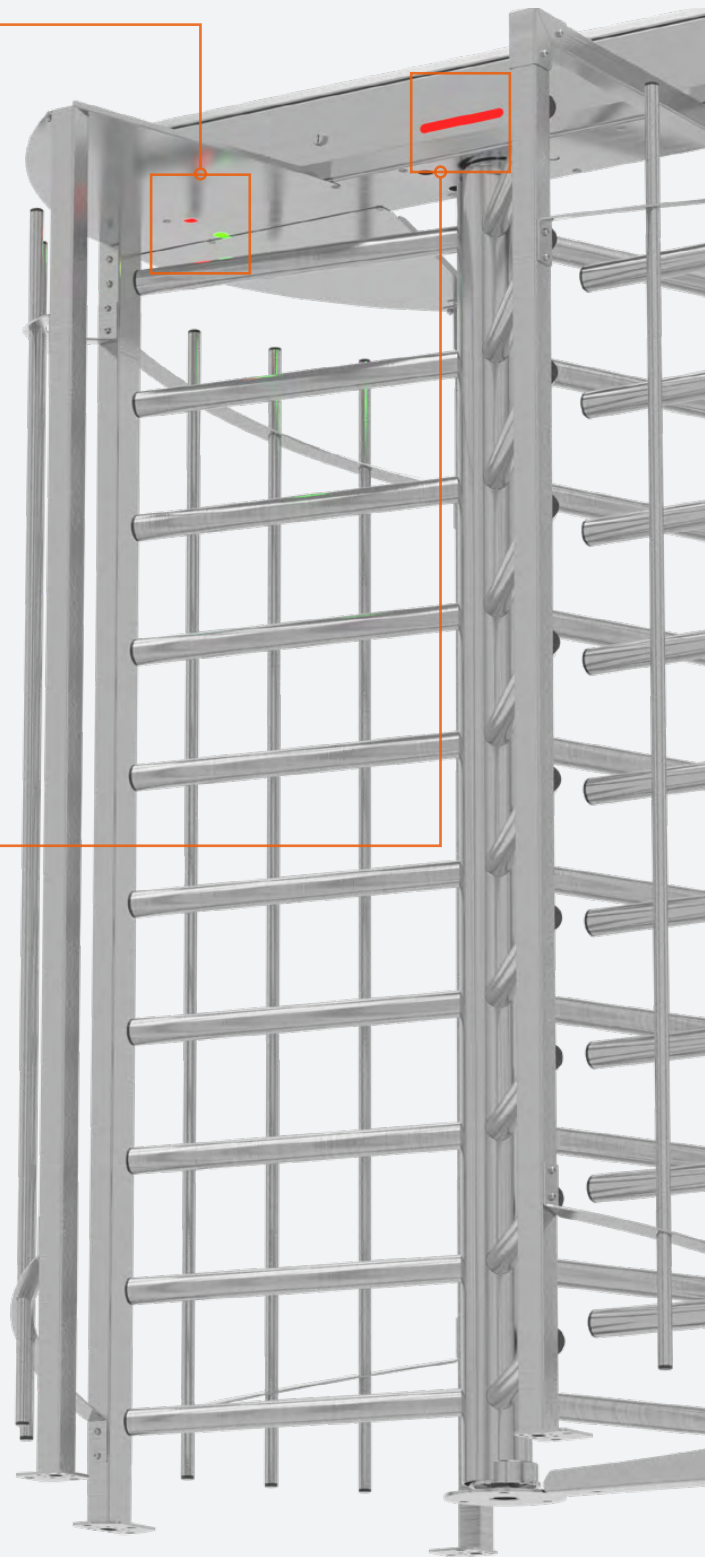

Sesame-S

full-height turnstiles

Technical specifications

Sesame-S

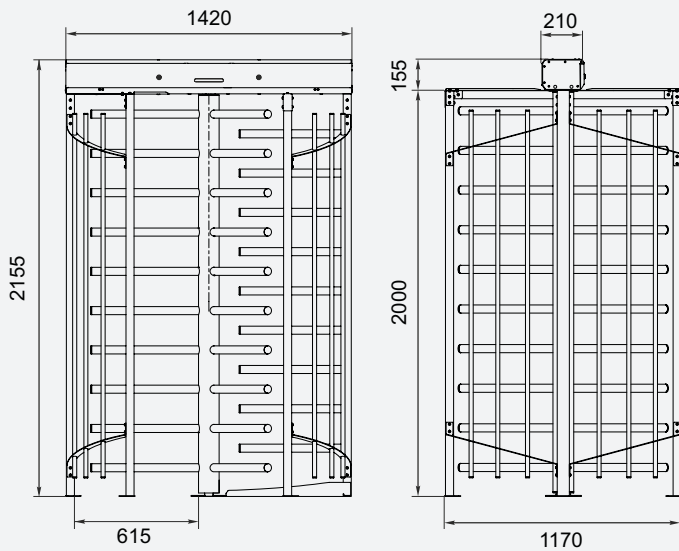

Sesame Basic-S

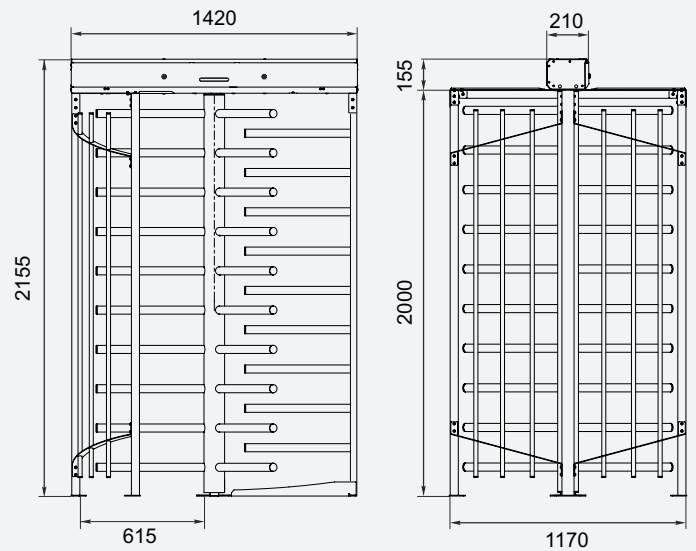

Technical specifications:

Model	Sesame-S		Sesame Basic-S	
Type	X-rotor	Y-rotor	X-rotor	Y-rotor
Passage width, mm	615		615	
Mechanism	SafeLock-EM			
Blocking system	Two electromechanical stop catches			
Emergency mode	Free pass in both directions			
Power fail	Fail safe (standard), Fail secure (option)			

Electrical specifications:

Maximum power consumption	160 W	160 W
Voltage	From the AC (100-240)V, 50/60Hz; from a DC source 12 V	

Finishing

Standard housing	Brushed SS AISI 304
Available housing	Brushed SS AISI 316; Polished SS AISI 304; Polished SS AISI 316; Powder coated any RAL upon request



TISO Global

Kyiv, Ukraine
tel.: +380 (44) 291-21-11
e-mail: sales@tiso.global
www.tiso.global

TISO ME

Dubai, UAE
Dubai South, B4 Building,
Office 231, P.O. Box 712990,
tel.: +971 4 548 67 77
tel.: +971 56 799 68 08
e-mail: sales.me@tiso.global
www.tiso.global

TISO UK

4, BYWORTH CLOSE
Bexhill-on Sea
East Sussex TN39 4NX
tel.: +44 7800777636
e-mail: sales@tisouk.com
www.tisouk.com

TISO APAC

Singapore
78 Bedok North Road,
Unit 14-232, 460078
tel.: +65 62506 0515
e-mail: sales.apac@tiso.global
www.tisoapac.com